

## RS 232/485 Input Settings / Close Contact

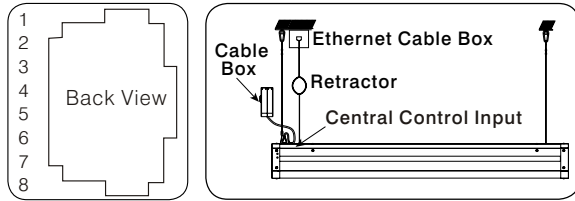

Crystal Socket

## Control Emitter Function / Address

1	Common line	5	Casing Down
2	Retracting the screen	6	Stop
3	Lowering the screen	7	Rs232 Input B
4	Casing up	8	Rs232 Input A

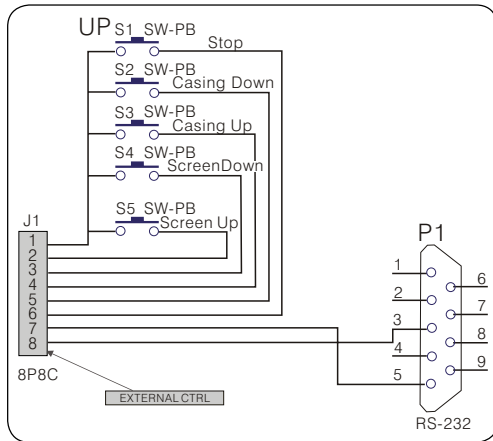

1. Central Control Format Agreement Communication Agreement Setting: data bits: 8 bits, start bits: 1 bit, stop bits: 1 bit, Baud Ratio: 2400.
2. Retracting the screen:  
0xFF 0xEE 0xEE 0xEE 0xDD
3. Stopping the screen:  
0xFF 0xEE 0xEE 0xEE 0xCC
4. Lowering the screen:  
0xFF 0xEE 0xEE 0xEE 0xEE
5. Retracting the casing:  
0xFF 0xEE 0xEE 0xEE 0xC9
6. Lowering the casing:  
0xFF 0xEE 0xEE 0xEE 0xE9
7. 232 setting: 2400, n, 8, 1 a continuous data sends two times, each time interval of 200 ms.

# gv

## GRANDVIEW®

### Protecting Your Screen:

- Keep away from direct sunlight or high temperatures.
- Examine both the front and back surfaces before retracting into the case to make sure it is free of dust, dirt, insects or other foreign matter.
- Use a soft brush or cloth to lightly remove any foreign particles.

### Cleaning Your Screen:

- Do not use any solvents, chemicals or abrasive cleaners on the screen surface.
- Use a mild detergent with warm water to remove any marks on the surface or screen case.
- Always immediately dab the screen with a soft cloth to avoid soap marks.
- Do not scrub the surface.

### Warranty: 12 Months

Imported and Distributed in Australia by  
Herma Technologies  
Factory 4A, 6 Albert St  
Preston, VIC 3072

For more information please go to  
[www.grandviewscreens.com.au](http://www.grandviewscreens.com.au)  
or call 1300 730 025

# gv

## GRANDVIEW®



Grandview Large Sky-Show  
User Manual

## To the Owner:

Congratulations on purchasing a Grandview Sky-Show.

### Important Notes:

- Please read this instruction manual before use.
- Please do not attempt to adjust or repair the product. You will void the warranty.
- Please retain this instruction manual for future reference.
- Handle the screen carefully during transportation.
- To ensure long lasting viewing enjoyment, always keep the screen rolled up when not in use.

### Warning

- Ensure the screen is hung by the looped suspension cables.
- The screen must be securely mounted before being operated. Failure to comply can cause the suspension cables to unravel resulting in the cables being tangled and possible screen damage occurring.
- When suspending the screen under load-bearing support, ensure the screen is hung level/straight.
- Damage caused to the product due to incorrect installation, suspension or operation is not covered by warranty.

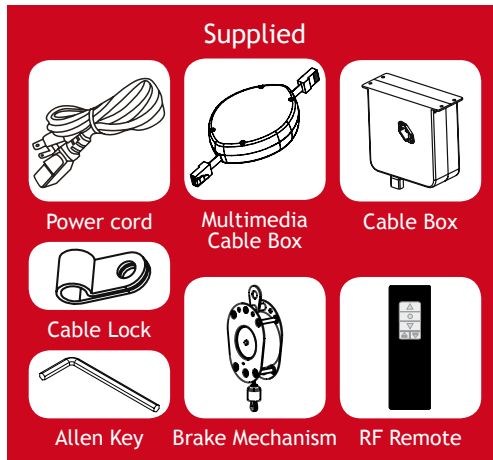

## Operational Instructions

### Step 1

Carefully unpack the screen. Securely attach the cable box to the ceiling.

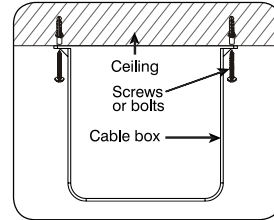

### Step 2

Mount the break mechanism and screen as shown below.

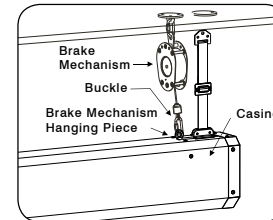

### Step 3

Insert the cable box plug and attach break mechanism.

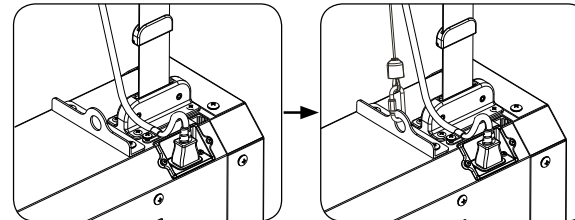

### Step 4

Plug the power cord into the Cable Box.

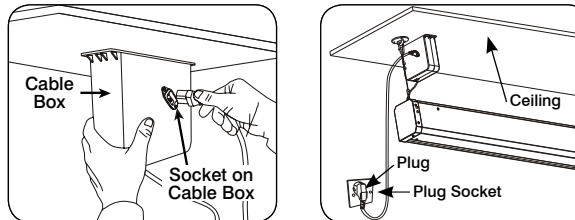

### Using RF Remote

Your remote control comes with batteries installed.

To operate your remote:

- Press ▲ to lift the screen
- Press ● to stop the screen
- Press ▼ to lower the screen
- ▲ ▼ The Micro switch is used for retracting or lowering cable.

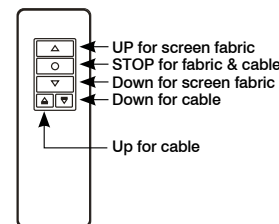

## Cable Limit Settings

(The limits are preset at min 300mm and max 4950mm)

- Turn the remote control over to locate the “Programming Mode” activation toggle switch.
- Press with a fine tip and the LED should light up, indicating “Programming Mode” is on.
- Press the micro “UP/DOWN” buttons to move the screen case to the required position. Press the STOP button when the desired limit is achieved.
- Press the Programming Mode toggle switch again to switch off programming mode and set the new limit.

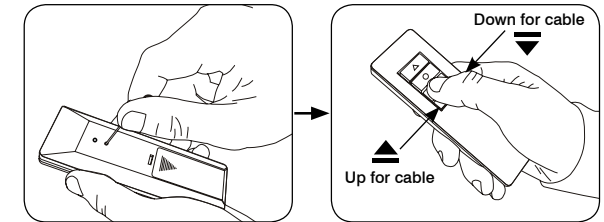

Please secure your safety limit lug at least 10mm above the new limit

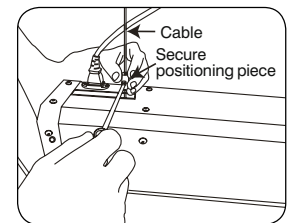

## Screen Limit Settings

The screen is fitted with two limits. The limits automatically stop the screen in the fully Up (top limit) and fully Down (bottom limit) positions. You can adjust the bottom limit to set your viewing height.

### Setting The Bottom Limit

*Caution: Setting the bottom limit beyond the black leader may render your screen inoperable and void your warranty*

The bottom limit switch is accessible through a grommeted hole at the back of the left side casing.

Lower the screen to the operating position then insert the supplied Allen key into the white coloured screw. Turn it clockwise to raise the screen or turn it anti-clockwise to lower the screen.

When lowering the bottom limit the screen will move as you adjust it.

When raising the bottom limit please lift and lower the screen with the remote to see the new position.