

GV Adjustable Short Throw Projector Mount

Parts:

GPCP-D is combined by GPCP and GPD

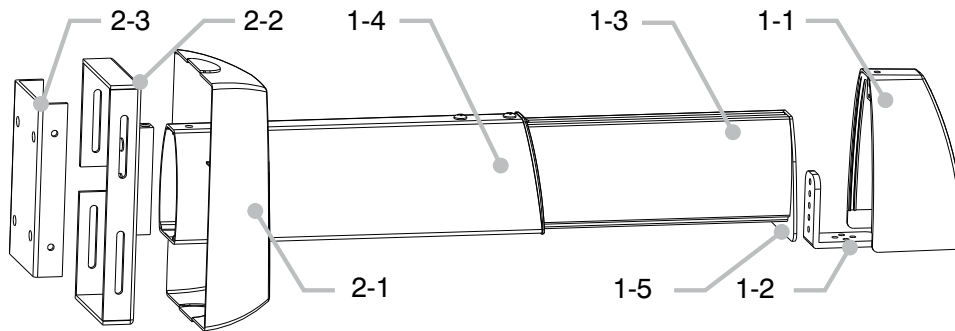

GPCP Main Bar Overview:

- 1-1 End Cap
- 1-2 'L' Bracket
- 1-3 Extender Arm
- 1-4 Main Arm
- 1-5 End Plate
- 2-1 Lower Cap
- 2-2 Cover Bracket
- 2-3 Wall Mounting Bracket

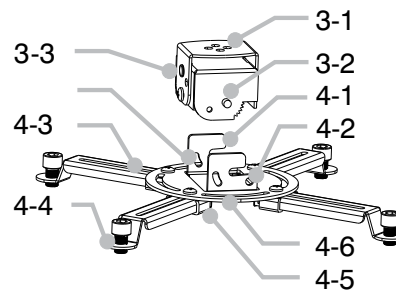

GPD Adjustment Overview:

- 3-1 Adjuster
- 3-2 Hanging Button
- 3-3 Horizontal Adjusting Hole
- 4-1 Installation Bracket
- 4-2 Vertical Adjusting Button
- 4-3 Installation Arm
- 4-4 Adjustable Nut
- 4-5 Sliding Installation Button
- 4-6 Installation Base

Accessories:

- ① M3X30 Philips Screw (4pcs)
- ② M4X30 Philips Screw (4pcs)
- ③ M5X30 Philips Screw (4pcs)
- ④ M5X8 Philips Screw (2pcs)
- ⑤ M6X12 Anti-Slip Screw (2pcs)
- ⑥ M5X10 Philips Screw (5pcs)
- ⑦ M6X35 Tapping Screw (4sets)
- ⑧ Ø6X50 Wood Screwn (4sets)

gv GRANDVIEW®
MEETS YOUR VISION.

www.grandviewscreens.com.au

GV Adjustable Short Throw Projector Mount

Instruction Manual:

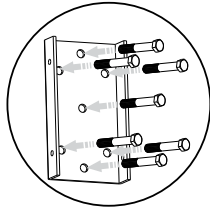

figure 1

1. Attach the Wall Mounting Bracket to the required height using appropriate fasteners (figure 1).

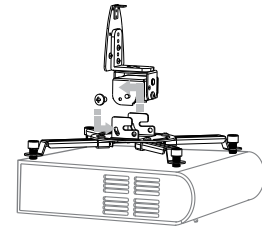

figure 2

2. Attach the Lower Bracket to the Wall Mounting Bracket - ensuring all the required cables are 'feed' through the desired slots (figure 2).

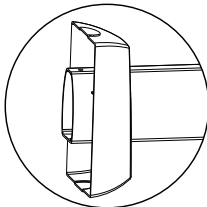

figure 3

3. Insert the Lower Cap over the end of the Main Arm then continue 'feeding' cables through the Main Arm and out the base of the Extender Arm (figure 3).

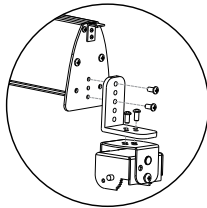

figure 5

4. Attach the lower Main Arm to the Lower Bracket (figure 4).

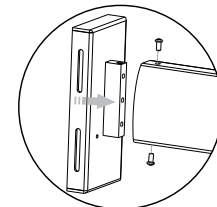

figure 4

5. Attach the "L" Bracket to the end-plate of the Extender Arm (figure 5).

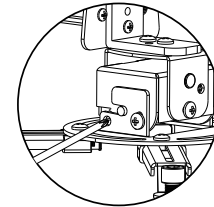

figure 6

6. Attached the Adjustor to the "L" Bracket (figure 6).

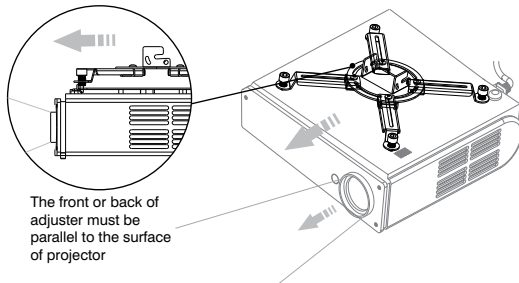

figure 7

7. Mount the projector to the Installation Bracket and then attach to the Installation Bracket, with the Projector to the Adjustor (figure 7).

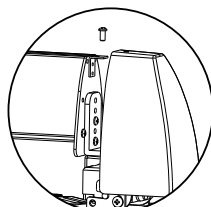

figure 8

8. Fasten all screws firmly and fit off the Top Cap (figure 8).